

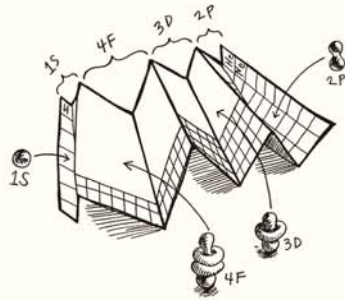





# A World From Dust

The periodic table maps out a sequence for life

## THE FOLDING PERIODIC TABLE



-  = ELEMENTS FOR BIOCHEMICAL BALANCE.
-  = ELEMENTS FOR BIOCHEMICAL BUILDING.
-  = ELEMENTS FOR BIOCHEMICAL CATALYSIS.
-  = ELEMENTS WITH CAPACITY FOR BOTH BUILDING + BALANCE

1S 																											2P 																
H																											He																
3 Li	4 Be																											5 B	6 C	7 N	8 O	9 F	10 Ne										
11 Na	12 Mg																											13 Al	14 Si	15 P	16 S	17 Cl	18 Ar										
19 K	20 Ca																											21 Sc	22 Ti	23 V	24 Cr	25 Mn	26 Fe	27 Co	28 Ni	29 Cu	30 Zn	31 Ga	32 Ge	33 As	34 Se	35 Br	36 Kr
37 Rb	38 Sr																											39 Y	40 Zr	41 Nb	42 Mo	43 Tc	44 Ru	45 Rh	46 Pd	47 Ag	48 Cd	49 In	50 Sn	51 Sb	52 Te	53 I	54 Xe
55 Cs	56 Ba	57 La	58 Ce	59 Pr	60 Nd	61 Pm	62 Sm	63 Eu	64 Gd	65 Tb	66 Dy	67 Ho	68 Er	69 Tm	70 Yb	71 Lu	72 Hf	73 Ta	74 W	75 Re	76 Os	77 Ir	78 Pt	79 Au	80 Hg	81 Tl	82 Pb	83 Bi	84 Po	85 At	86 Rn												
87 Fr	88 Ra	89 Ac	90 Th	91 Pa	92 U	93 Np	94 Pu	95 Am	96 Cm	97 Bk	98 Cf	99 Es	100 Fm	101 Md	102 No	103 Lr	104 Rf	105 Db	106 Sg	107 Bh	108 Hs	109 Mt	110 Ds	111 Rg	112 Cn	113 Uut	114 Uuq	115 Uup	116 Uuh	117 Uus	118 Uuo												

4F  
RARE-EARTH METALS  

3D  
TRANSITIONAL METALS  
